

eM3-ROT-1000

The eMove eM3-ROT-800 is a compact, three degrees of freedom (pitch, roll, heave) electric motion system with rotary actuators, designed for use in simulation systems with low payload that do not necessarily require six degrees of freedom.

Typical applications are simulators for construction and mining equipment, driving simulators, entertainment, etc.

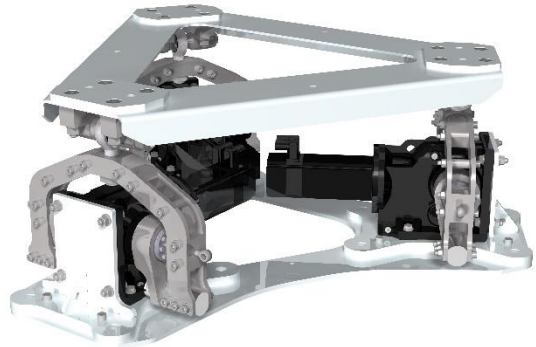

System performance

	Excursions - Single DOF			Velocity		Acceleration	
Heave	-0.10	0.10	m	0.3	m/s	4	m/s ²
Roll	-12.3	12.3	deg	15	deg/s	100	deg/s ²
Pitch	-14.1	14.7	deg	15	deg/s	100	deg/s ²

Payload specification

Gross Moving Load		1000	kg (payload including upper frame)
CoG height above MPC(*)		500	mm
Moments of Inertia	lxx	500	kg m ²
	lyy	500	kg m ²

CoG: Center of Gravity – MPC: Moving Platform Centroid

Main dimensions

Ground circle diameter	1.2	m (excluding control cabinet)
Settled height (floor to top of platform)	0.5	m (excluding control cabinet)
System weight	400	kg

Power requirements

Mains power	3-phase 380-480 VAC +/- 10%, 50/60 Hz
-------------	---------------------------------------